

# PANELS

## Wood Ceilings & Walls

Elevate the design of a traditional suspended ceiling with this versatile collection of lay-in, semi-concealed, and concealed access panel options. Available in a variety of wood veneers and finishes, this collection of panels is offered in multiple configurations, including perforations, slots, and channels.



### APPLICATIONS

- Conference Rooms
- Private Offices
- Lobbies & Atria
- Hospitality

### VENEERS AND FINISHES

#### Plain Slice Veneers

Natural veneers with distinct grains, cathedral arches, and natural variation in color and texture

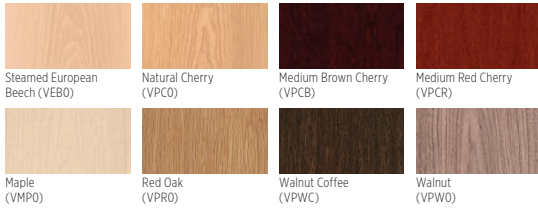

Steamed European Beech (VEBO)

Natural Cherry (VPCO)

Medium Brown Cherry (VPCB)

Medium Red Cherry (VPCR)

Cherry (RRCO)

Maple (RMCO)

Narrow Cane Bamboo Caramel (BNCO)

Maple (VMPO)

Red Oak (VPRO)

Walnut Coffee (VPWC)

Walnut (VPWO)

Walnut (RWNO)

Quartered Blonde (ROBO)

Narrow Cane Bamboo Natural (BNNO)

Actual shades or grains may vary; request a sample for more accurate finish portrayal. Additional special order options available.

#### Reconstituted Veneers

Veneers engineered for visual and color consistency

#### Bamboo Veneers

Veneers engineered from rapidly-renewable bamboo

### FEATURES AND BENEFITS

- Choose from a variety of perforation, channel, and slot options for visual appeal and acoustic performance
- Select from a variety of fully-accessible installation options including lay-in, semi-concealed and concealed access
- Design from our veneer and finish library or specify a custom veneer, finish or paint color to match project elements
- Installation components are included when ordered through our Technical Sales Team
- FSC® available upon request

### SUSPENSION SYSTEM OPTIONS

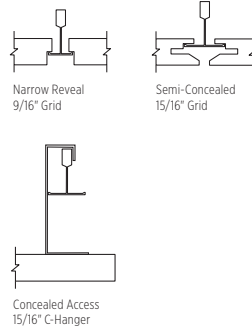

### VISUAL OPTIONS

#### Unperforated

#### Perforated

#### Slotted

#### Channeled (U-Groove)

#### Channeled (V-Groove)

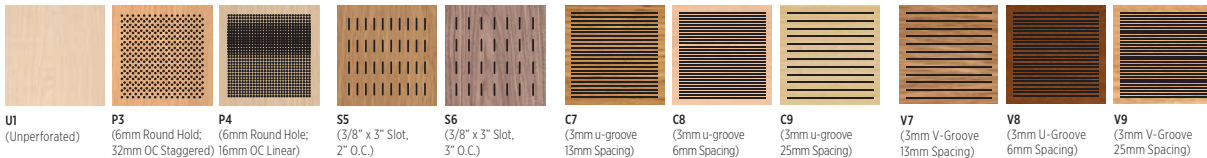

U1 (Unperforated)

P3 (6mm Round Hold, 32mm OC Staggered)

P4 (6mm Round Hole, 16mm OC Linear)

S5 (3/8\"/>

S6 (3/8\"/>

C7 (3mm U-groove, 13mm Spacing)

C8 (3mm U-groove, 6mm Spacing)

C9 (3mm U-groove, 25mm Spacing)

V7 (3mm V-Groove, 13mm Spacing)

V8 (3mm V-Groove, 6mm Spacing)

V9 (3mm V-Groove, 25mm Spacing)

Additional visual options available, see special order options. Please contact your local sales representative or Wood Ceilings and Walls Technical Specialist for more information.

**LEED® v4**



RECYCLED CONTENT	80%
✓ EQ: Acoustic Performance	
✓ MR: Sourcing of Raw Materials <sup>1</sup>	
✓ MR: Regional Material (Location Specific)	

<sup>1</sup>Ask about FSC® availability (FSC-C151918)  
 Additional Credits may apply; contact Wood Ceilings and Walls Technical Sales for information  
 LEED® is a registered trademark of the U.S. Green Building Council.

# PANELS



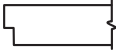
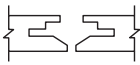





## Wood Ceilings & Walls

### STANDARD PRODUCT OFFERING

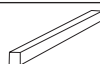
		Dimensions (W x L x H) (in.)	Suspension	Fire Class	Weight (lbs./sq. ft.)
<b>NARROW REVEAL (9/16")</b>					
	5005_____	24 x 24 x 3/4	9/16	A	2.81
	5010_____	24 x 48 x 3/4	9/16	A	2.81
	5015_____	12 x 48 x 3/4	9/16	A	2.81
	5020_____	12 x 72 x 3/4	9/16	A	2.81
	5025_____	24 x 72 x 3/4	9/16	A	2.81
	5006_____	30 x 30 x 3/4	9/16	A	2.81
<b>SEMI-CONCEALED (15/16")</b>					
	5205_____	24 x 24 x 3/4	15/16	A	2.81
	5210_____	24 x 48 x 3/4	15/16	A	2.81
	5215_____	12 x 48 x 3/4	15/16	A	2.81
<b>CONCEALED ACCESS (C-HANGER 15/16")</b>					
	5505_____	24 x 48 x 3/4	15/16	A	3.0
	5510_____	24 x 72 x 3/4	15/16	A	3.0
	5515_____	24 x 96 x 3/4	15/16	A	3.0

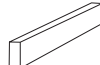
CAN'T FIND A SIZE? Additional configurations, sizes, and finishes available. Contact Wood Ceilings and Walls Technical Sales, call 888-357-2345

### ACCESSORIES

INSTALLATION ACCESSORIES		Product Name	Color	Use
	C-108	Semi-Concealed Safety Clip	Metal	Minimum four (4) safety clips per semi-concealed panel, two (2) clips per 2' side included with semi-concealed panel order; additional clips sold by the piece
	C-119	C-Hanger	Metal	C-hangers required for Concealed Access installation included with panel order: eight (8) per 96" panel, six (6) per 72", four (4) per 48"; additional components available by the piece as needed
TRIM AND TRIM ACCESSORIES		Product Name	Color	Use
	1005T2_____	2" x 96" x 3/4" Trim	Veneer Finishes	2" veneered perimeter trim; each 96" trim piece includes one (1) 3" Alignment Splice Plate (C-101) and four (4) Panel Edge Fixing Brackets (C-113) for trim installation
	1015T4_____	4" x 96" x 3/4" Trim	Veneer Finishes	4" veneered perimeter trim; each 96" trim piece includes one (1) 3" Alignment Splice Plate (C-101) and four (4) 90 Degree Perimeter Trim Brackets (C-116) for trim installation
	1025T6_____	6" x 96" x 3/4" Trim	Veneer Finishes	6" veneered perimeter trim; each 96" trim piece includes one (1) 3" Alignment Splice Plate (C-101) and four (4) 90 Degree Perimeter Trim Brackets (C-116) for trim installation
	C-116	90 Degree Perimeter Trim Bracket	Veneer Finishes	For attaching perimeter trim to modules; one (1) clip per linear foot of trim
	C-113	Panel Fixing Bracket	Metal	For attaching 2" perimeter trim or trim proud of the product face; four (4) clips per 96" length of trim
	C-100	90 Degree Perimeter Trim Clip	Veneer Finishes	For securing 90 degree perimeter trim corners; one (1) clip required for each corner
	C-101	3" Alignment Splice Plate	Veneer Finishes	For splicing lengths of trim; one (1) clip required for each connection

Trim and Trim Accessories sold by the piece and ordered separately as needed for the specific installation and includes the installation accessories as noted.

### ACOUSTICAL INFORMATION

Visual	Theatre Black f (1")		Symphony m HNRC	
	NRC	CAC	NRC	CAC
P3	0.70	28	0.70	37
P4	0.75	28	0.75	37
S5	0.80	28	0.80	37
S6	0.70	28	0.70	37
C7	0.80	28	0.75	37
C8	0.90	28	0.80	37
C9	0.60	28	0.70	37

Pattern UI 38 CAC

### UNDERSTANDING ITEM NUMBERS

To specify or order a specific product, include the 4-digit Item Number followed by the 2-character Visual Code and the 4-character Color Code.

**Example:** To order a 2 x 2' perforated (P3), narrow reveal panel in Narrow Cane Bamboo Natural, the item number would be **5005 P3 BNNO**

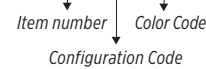

# PANELS

## Wood Ceilings & Walls

### SPECIAL ORDER VENEERS AND FINISHES



Actual shades or grains may vary; request a sample for more accurate finish portrayal.

### SPECIAL ORDER PANEL VISUAL OPTIONS



### SPECIAL ORDER CONFIGURATIONS

Contact Wood Ceilings and Walls Technical Sales for more information on custom configurations, visual options, and additional installation methods.

### SPECIAL ORDER DIMENSIONAL OPTIONS

	Width	Length
<b>Lay-In*</b>	Up to 2'	Up to 6'
<b>Semi-Concealed</b>	Up to 2'	Up to 4'
<b>Concealed Access</b>	Up to 4'	Up to 8'
<b>Walls</b>	Up to 4'	Up to 8'

\*30" x 30" available

### SPECIAL ORDER INSTALLATION OPTIONS

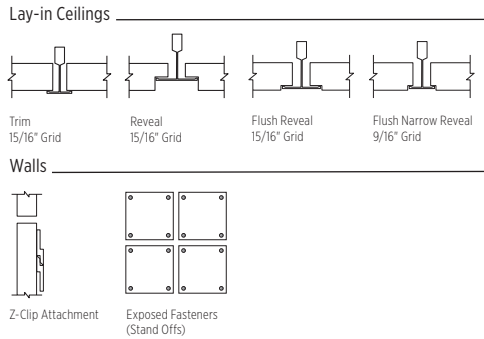

# PANELS

## Wood Ceilings & Walls

### INSTALLATION EXAMPLES

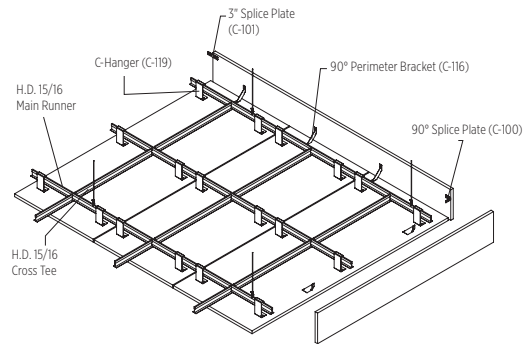
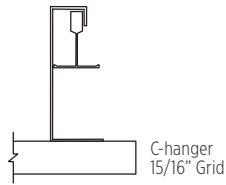
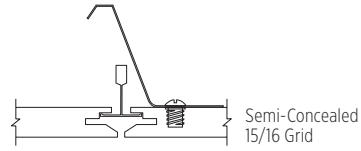
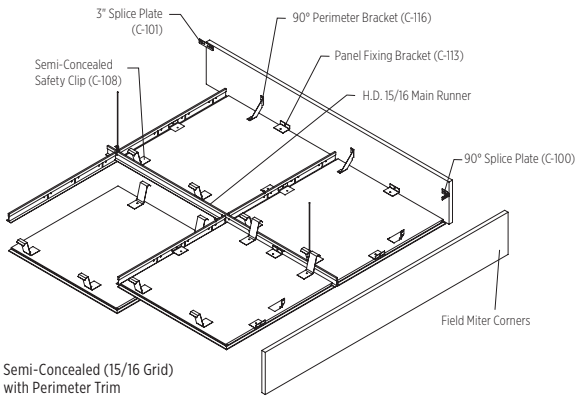
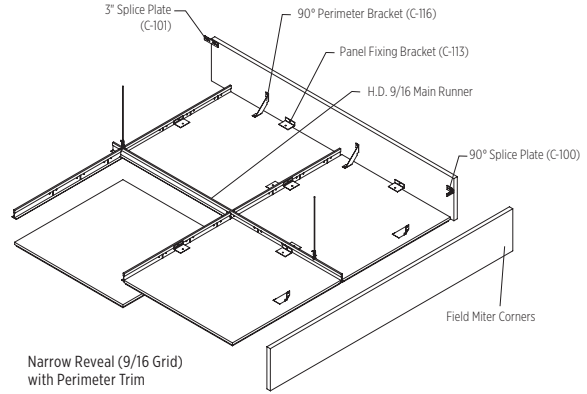
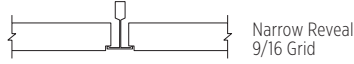

# PANELS

## Wood Ceilings & Walls

### PHYSICAL DATA

#### MATERIAL

Fire-retardant MDF or Fire-retardant Particle Board

#### SURFACE FINISH

Clear or tinted top with 20% sheen

#### FIRE CLASS (ASTM E1264)

Class A (Composite) per ASTM E84/ULC S102  
Flame Spread: 25 or less  
Smoke Developed: 50 or less

#### SITE CONDITIONS

Wood panels must be acclimatized for 72 hours prior to installation. Maintain relative humidity between 25% and 55% and temperature between 50°F and 89°F (10°C and 32°C) for the life of the product.

Wood is a natural material with varying grain and color characteristics. Characteristics may vary from panel to panel.

#### SEISMIC RESTRAINT

See installation instructions for seismic area installation information.

#### WARRANTY

Full warranty information can be found at [CertainTeed.com/ceilings](https://www.CertainTeed.com/ceilings).



### CertainTeed

CEILINGS • DECKING • FENCE • GYPSUM • INSULATION • RAILING • ROOFING • SIDING • TRIM  
20 Moores Road Malvern, PA 19355 Professional: 800-233-8990 Consumer: 800-782-8777 [certainteed.com](https://www.certainteed.com)