

METAL CEILINGS

PLANK & TILE
SNAP-IN

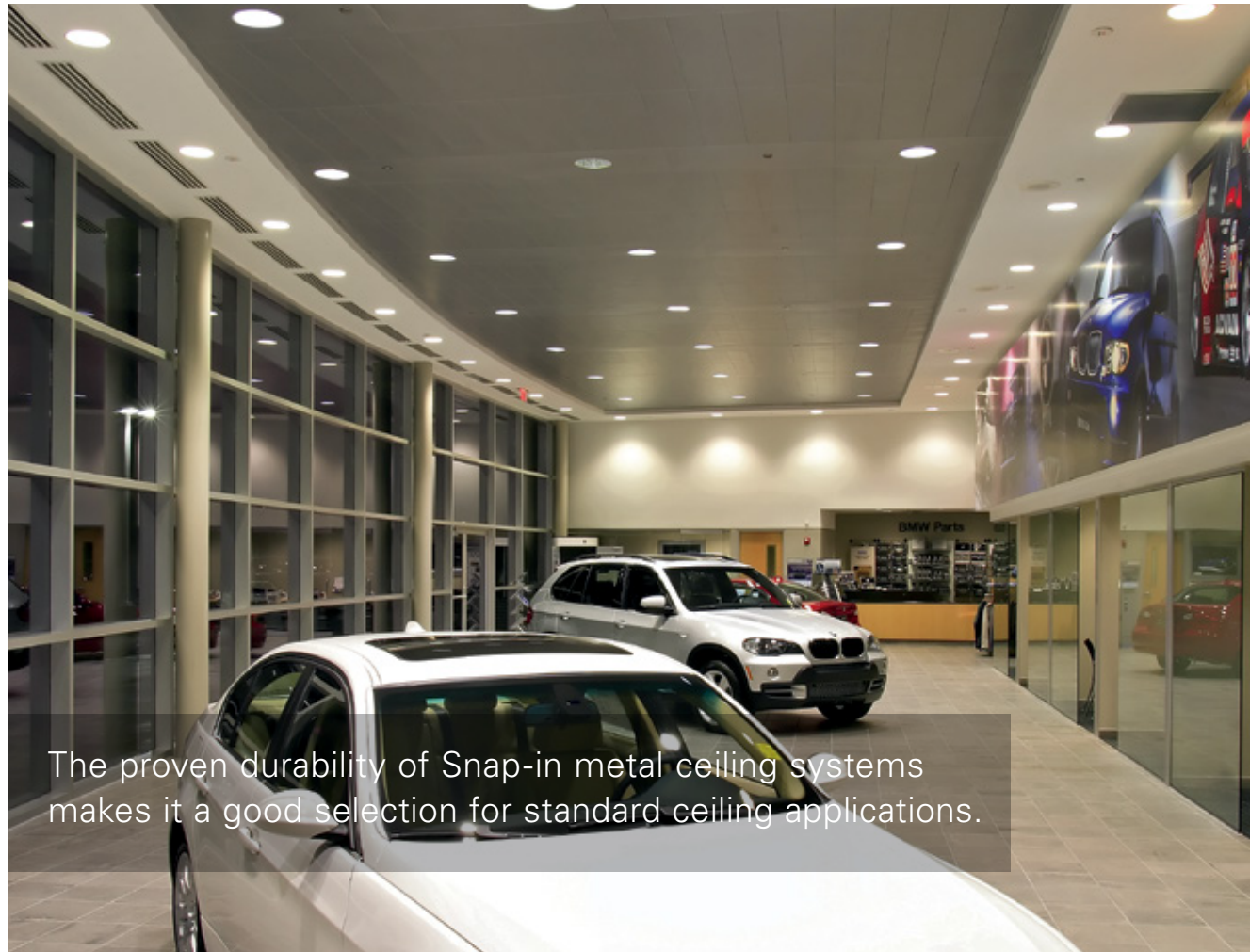

The proven durability of Snap-in metal ceiling systems makes it a good selection for standard ceiling applications.

Project: Auto Showroom, Chattanooga, TN; Snap-In

KEY FEATURES

- Three panel size sets:
 - 12" up to 96"
 - 24" x 24"
 - 24" x 48"
- Square-edge design
- Waste reduction with factory fabricated dimensional material
- Downweight: reduce dead load with lightweight aluminum
- Interior and exterior applications
- Compatible with industry standard lighting, HVAC, speaker, fire safety, and security services

TYPICAL ISOMETRICS

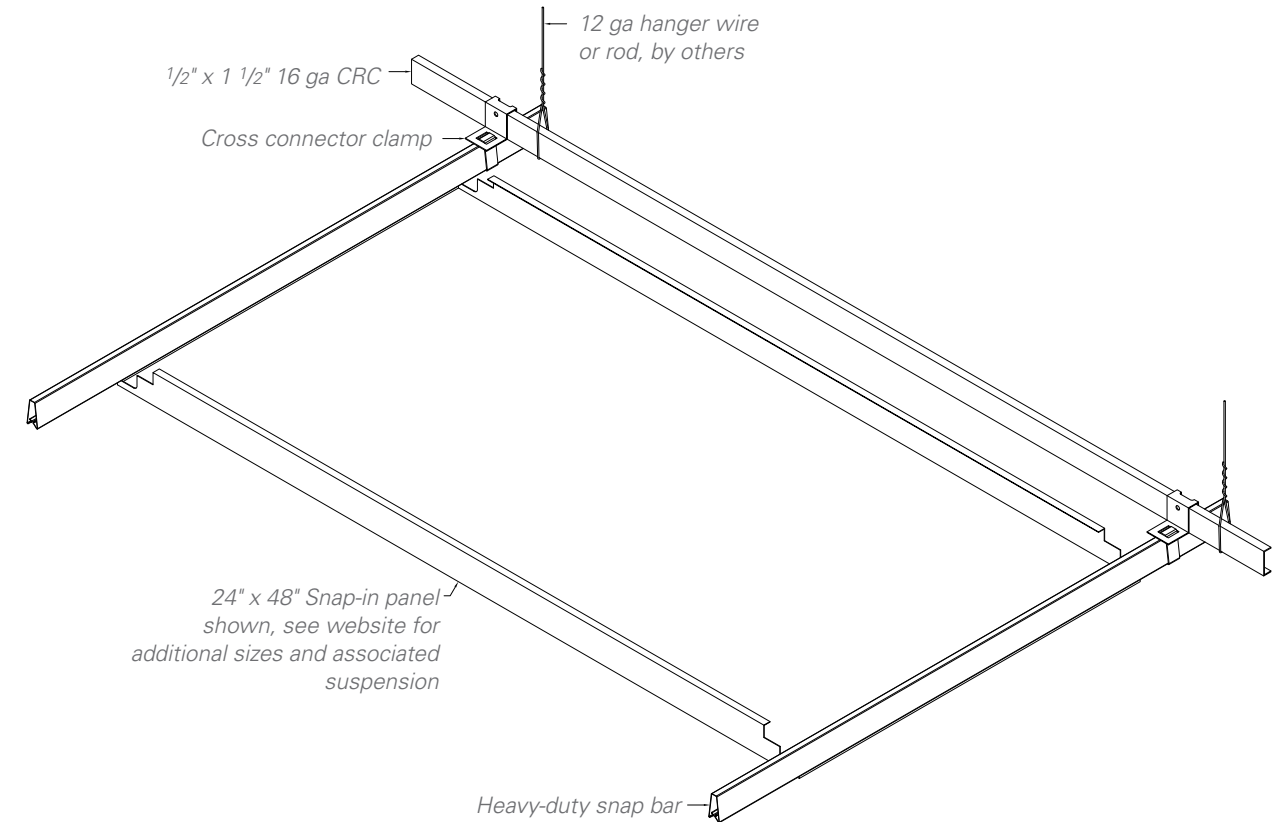

PERFORATION PATTERNS

Standard patterns shown. See Resources section to see all perforation patterns. Scale shown: 1:1, unless otherwise noted.

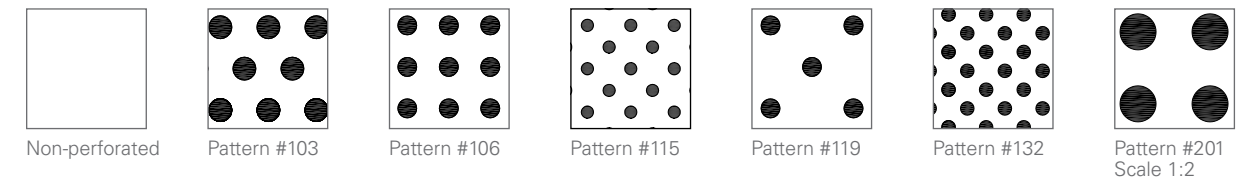

PHYSICAL DATA

Substrate: Aluminum
Warranty: 1 year
Seismic rating: Zones A,B,C,D,E,F
Fire rating: Class A Fire Rated per ASTM E84
 – Painted or anodized metal: Flame spread: ≤ 25, Smoke ≤ 50
Weight: Varies 0.75 – 1.0 lbs./sq.ft.
Wind load: N/A
Recycled content: Up to 85%
Light reflectance (LR) Coefficient per ASTM E1264 & ASTM E1477:
 – Varies with finish
 – Cotton White: LR = 0.81
Acoustical ratings – NRC: See Resources section.

BIM

REVIT files available for BIM contributions, see website for details.

LEED V4 CREDITS

EA: Optimize Energy Performance
 MR: Building Product Disclosure
 EQ: Low-Emitting Materials
 EQ: Indoor Air Quality Assessment
 EQ: Daylight
 EQ: Acoustic Performance

CERTIFICATIONS

GREENGUARD Gold Certified
 EPDs – available upon request

METAL CEILINGS

PLANK & TILE
SNAP-IN

COLORS & FINISHES

A wide choice of colors and finishes are available and some carry a premium price over manufacturer's standard colors. Custom color matching is available upon request. Minimum quantities and lead times may apply. See website for the most up to date information and to order samples. Colors are for illustration purposes only.

STANDARD PAINT COLORS



Natural
7163



Cotton White
0280

CUSTOM COLORS

Premium custom colors.



Custom

WHITE FINISH OPTIONS

Powder-coat paint finish for Arctic White #1015P (Gloss 10-20); Crystalline White #1050P (Gloss 45-55); Supernova White #1085P (Gloss 80-90)

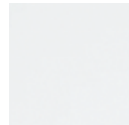

Arctic White
1015P

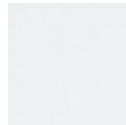

Crystalline White
1050P

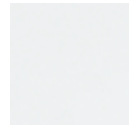

Supernova White
1085P

DAYLIGHTING WHITE PAINT FINISH

Powder-coat paint finish offering LRV 96; non-glare, 3% low gloss finish. Certified by: Applied Technical Services, Inc. Test Report No. D233185. Test reports available by request.

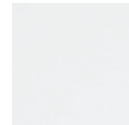

Performance White
9603P

BLACK FINISH OPTIONS

Powder-coat paint finish for Starless Black #5000P (Matte); Raven Black #5030P (Gloss 25-35); Sable Black #5060P (Gloss 65-75); Wet Glass Black #5095P (Gloss 90-95)



Starless Black
5000P



Raven Black
5030P



Sable Black
5060P



Wet Glass Black
5095P



Project: Auto Showroom, Chattanooga, TN; Snap-In