

# TECHNICAL BULLETIN

## Restoration Millwork® Corner with Flange Installation Instructions

### Installation instructions for Restoration Millwork® One-Piece Corner using Restoration Millwork® Nail Flange inserts.

The grooved design incorporated into every style of Restoration Millwork one-piece corners accommodates traditional face nailing methods. However, for a cleaner installation option that eliminates the need for face nailing by providing hidden attachment points, consider using Restoration Millwork PVC flange inserts.

Introduced in 2013, the flange inserts feature molded protrusions that fit directly into the grooves of the corner piece. The flanges, rather than the corner piece, are secured tightly to the wall with flat head screws. With no nail holes to fill, corners can be finished more quickly and neatly.

#### One-Piece Corner Piece Sizes and Styles

Restoration Millwork one-piece corners come in both smooth and TrueTexture™ woodgrain finish, and two width options are available: 3-1/2" and 5-1/2". One-piece corner pieces come with or without a built-in j-pocket. All styles have 1" thickness, are natural white and are available in 10' and 20' lengths.

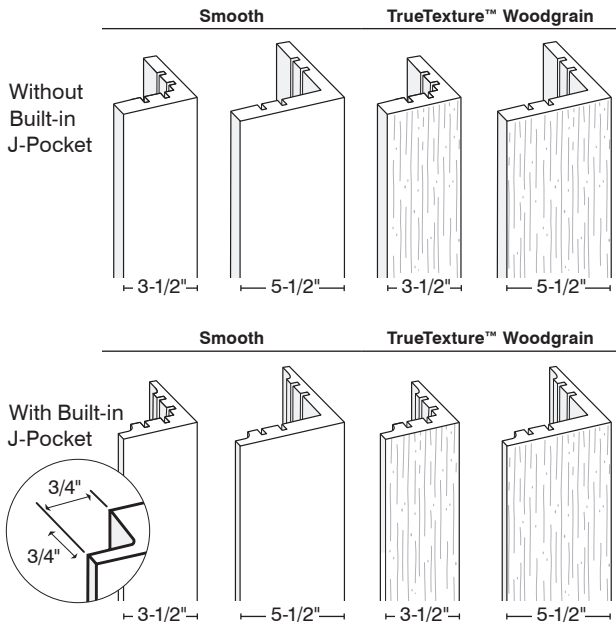

#### A Note on Flange Dimensions

- Flange length is 9' 11-3/4".
- Two flanges are needed for each side of a 20' one-piece corner.
- Space flanges 1/2" apart to allow for expansion and contraction.

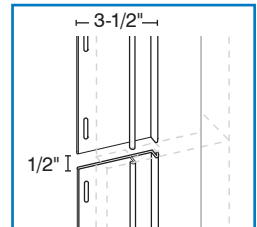

#### When attaching CertainTeed Restoration Millwork nail flanges to one-piece corners, please adhere to the following recommendations:

- To assemble corner and flanges, use a flat solid surface that supports the corner.
- Insert flange into groove starting from one end.
- To fully seat the flange in the groove, place a piece of scrap Restoration Millwork or wood atop the flange and gently hammer it, working your way down the length of the flange and ensuring it is fully seated into the grooves.

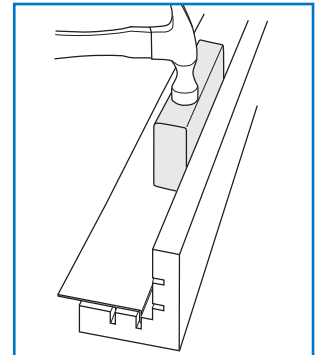
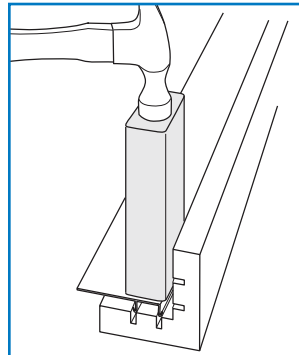

**Do NOT hammer directly on the flange.**

The scrap piece should be taller than the adjacent edge of the corner to prevent damaging the corner.

**NOTE:** If flange can slide in grooves, attach a screw through the backside of the flange into the Restoration Millwork corner making sure the screw does not protrude through the exposed face. One screw per flange located at the top of the corner should be sufficient.

**When installing CertainTeed Restoration Millwork one-piece corners with attached nail flanges, please adhere to the following recommendations:**

- DO NOT NAIL.
- Fasteners must be noncorrosive, self-tapping, pan head or washer head screws, or oval head with countersunk washer screws with at least 5/16" diameter head and 1/8" diameter shaft.
- Screws must be at least 1-1/8" long.
- DO NOT SCREW TIGHT. Leave 1/16" between the screw head and nail flange to allow for expansion and contraction.
- Position the uppermost screw at the top of the slot (Figure A).
- All remaining screws must be positioned in the middle of the slot (Figure B).
- Install screws every 12" to 16".

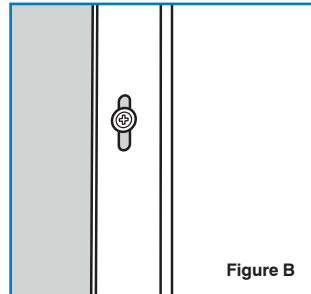
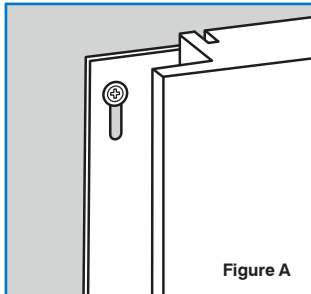
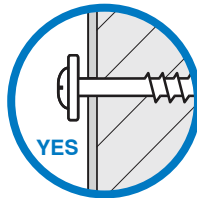
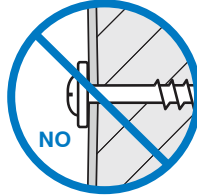

**Important Information**

- All products must be installed in accordance with all national, state and local building codes. Be sure to check with your local code official or governing body for the building requirements in your area.
- All installation requirements listed in the CertainTeed Restoration Millwork Installation Guidelines (RM003) must be met.
- Failure to comply with CertainTeed installation instructions and/or applicable building codes may affect product performance and void the product warranty.
- **NOTE: When the terms "recommend" and "should" are used in this bulletin, the step is optional for installing Restoration Millwork exterior trim. However, it is included because the step represents best practice. When the terms "required" and "must" are used, the step is a necessary part of the installation process and must be adhered to.**

**Resources for design and installation of CertainTeed Restoration Millwork exterior trim:**

[www.certainteed.com/resources/RM003.pdf](http://www.certainteed.com/resources/RM003.pdf)

**CertainTeed Sales Support Group: 800-233-8990**

**ASK ABOUT OUR OTHER CERTAINTEED® PRODUCTS AND SYSTEMS:**

ROOFING • SIDING • TRIM • DECKING • RAILING • FENCE • FOUNDATIONS  
GYPSUM • CEILINGS • INSULATION • PIPE

[www.certainteed.com](http://www.certainteed.com) <http://blog.certainteed.com>

CertainTeed Corporation  
P.O. Box 860  
Valley Forge, PA 19482

**Professional: 800-233-8990**  
**Consumer: 800-782-8777**

© 1/13 CertainTeed Corporation  
Code No. RM062